

# ADAAG RECREATION FACILITIES

## SWIMMING POOLS, WADING POOLS AND SPAS

### ADA SCOPING REQUIREMENTS:

---

#### **242 Swimming Pools, Wading Pools, and Spas**

**242.1 General.** Swimming pools, wading pools, and spas shall comply with 242.

**242.2 Swimming Pools.** At least two *accessible* means of entry shall be provided for swimming pools. *Accessible* means of entry shall be swimming pool lifts complying with 1009.2; sloped entries complying with 1009.3; transfer walls complying with 1009.4; transfer systems complying with 1009.5; and pool stairs complying with 1009.6. At least one *accessible* means of entry provided shall comply with 1009.2 or 1009.3.

#### **EXCEPTIONS:**

1. Where a swimming pool has less than 300 linear feet (91 m) of swimming pool wall, no more than one *accessible* means of entry shall be required provided that the *accessible* means of entry is a swimming pool lift complying with 1009.2 or sloped entry complying with 1009.3.

2. Wave action pools, leisure rivers, sand bottom pools, and other pools where user access is limited to one area shall not be required to provide more than one *accessible* means of entry provided that the *accessible* means of entry is a swimming pool lift complying with 1009.2, a sloped entry complying with 1009.3, or a transfer system complying with 1009.5.

3. *Catch pools* shall not be required to provide an *accessible* means of entry provided that the *catch pool* edge is on an *accessible* route.

**Advisory 242.2 Swimming Pools.** Where more than one means of access is provided into the water, it is recommended that the means be different. Providing different means of access will better serve the varying needs of people with disabilities in getting into and out of a swimming pool. It is also recommended that where two or more means of access are provided, they not be provided in the same location in the pool. Different locations will provide increased options for entry and exit, especially in larger pools.

**Advisory 242.2 Swimming Pools Exception 1.** Pool walls at diving areas and areas along pool walls where there is no pool entry because of landscaping or adjacent structures are to be counted when determining the number of accessible means of entry required.

**242.3 Wading Pools.** At least one *accessible* means of entry shall be provided for wading pools. *Accessible* means of entry shall comply with sloped entries complying with 1009.3.

**242.4 Spas.** At least one *accessible* means of entry shall be provided for spas. *Accessible* means of entry shall comply with swimming pool lifts complying with 1009.2; transfer walls complying with 1009.4; or transfer systems complying with 1009.5.

**EXCEPTION:** Where spas are provided in a cluster, no more than 5 percent, but no fewer than one, spa in each cluster shall be required to comply with 242.4.

# ADAAG RECREATION FACILITIES

## SWIMMING POOLS, WADING POOLS AND SPAS

### **ABA SCOPING REQUIREMENTS:**

---

#### **F242 Swimming Pools, Wading Pools, and Spas**

**F242.1 General.** Swimming pools, wading pools, and spas shall comply with F242.

**F242.2 Swimming Pools.** At least two *accessible* means of entry shall be provided for swimming pools. *Accessible* means of entry shall be swimming pool lifts complying with 1009.2; sloped entries complying with 1009.3; transfer walls complying with 1009.4; transfer systems complying with 1009.5; and pool stairs complying with 1009.6. At least one *accessible* means of entry provided shall comply with 1009.2 or 1009.3.

#### **EXCEPTIONS:**

1. Where a swimming pool has less than 300 linear feet (91 m) of swimming pool wall, no more than one *accessible* means of entry shall be required provided that the *accessible* means of entry is a swimming pool lift complying with 1009.2 or sloped entry complying with 1009.3.

2. Wave action pools, leisure rivers, sand bottom pools, and other pools where user access is limited to one area shall not be required to provide more than one *accessible* means of entry provided that the *accessible* means of entry is a swimming pool lift complying with 1009.2, a sloped entry complying with 1009.3, or a transfer system complying with 1009.5.

3. *Catch pools* shall not be required to provide an *accessible* means of entry provided that the *catch pool* edge is on an *accessible* route.

**Advisory F242.2 Swimming Pools.** Where more than one means of access is provided into the water, it is recommended that the means be different. Providing different means of access will better serve the varying needs of people with disabilities in getting into and out of a swimming pool. It is also recommended that where two or more means of access are provided, they not be provided in the same location in the pool. Different locations will provide increased options for entry and exit, especially in larger pools.

**Advisory F242.2 Swimming Pools Exception 1.** Pool walls at diving areas and areas along pool walls where there is no pool entry because of landscaping or adjacent structures are to be counted when determining the number of accessible means of entry required.

**F242.3 Wading Pools.** At least one *accessible* means of entry shall be provided for wading pools. *Accessible* means of entry shall comply with sloped entries complying with 1009.3.

**F242.4 Spas.** At least one *accessible* means of entry shall be provided for spas. *Accessible* means of entry shall comply with swimming pool lifts complying with 1009.2; transfer walls complying with 1009.4; or transfer systems complying with 1009.5.

**EXCEPTION:** Where spas are provided in a cluster, no more than 5 percent, but no fewer than one, spa in each cluster shall be required to comply with F242.4.

# ADAAG RECREATION FACILITIES

## SWIMMING POOLS, WADING POOLS AND SPAS

### ADAAG SECTION 1009

---

#### 1009 Swimming Pools, Wading Pools, and Spas

**1009.1 General.** Where provided, pool lifts, sloped entries, transfer walls, transfer systems, and pool stairs shall comply with 1009.

**1009.2 Pool Lifts.** Pool lifts shall comply with 1009.2.

**Advisory 1009.2 Pool Lifts.** There are a variety of seats available on pool lifts ranging from sling seats to those that are preformed or molded. Pool lift seats with backs will enable a larger population of persons with disabilities to use the lift. Pool lift seats that consist of materials that resist corrosion and provide a firm base to transfer will be usable by a wider range of people with disabilities. Additional options such as armrests, head rests, seat belts, and leg support will enhance accessibility and better accommodate people with a wide range of disabilities.

**1009.2.1 Pool Lift Location.** Pool lifts shall be located where the water level does not exceed 48 inches (1220 mm).

#### EXCEPTIONS:

1. Where the entire pool depth is greater than 48 inches (1220 mm), compliance with 1009.2.1 shall not be required.

2. Where multiple pool lift locations are provided, no more than one pool lift shall be required to be located in an area where the water level is 48 inches (1220 mm) maximum.

**1009.2.2 Seat Location.** In the raised position, the centerline of the seat shall be located over the deck and 16 inches (405 mm) minimum from the edge of the pool. The deck surface between the centerline of the seat and the pool edge shall have a slope not steeper than 1:48.

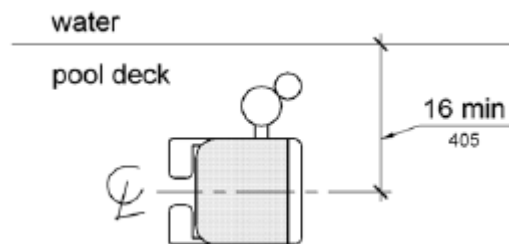
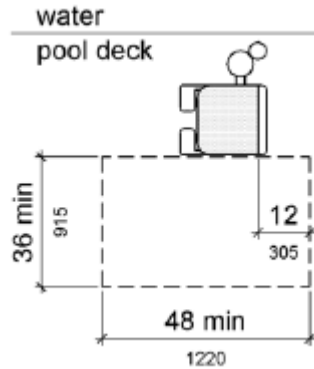

**Figure 1009.2.2 Pool Lift Seat Location**

# ADAAG RECREATION FACILITIES

## SWIMMING POOLS, WADING POOLS AND SPAS

**1009.2.3 Clear Deck Space.** On the side of the seat opposite the water, a clear deck space shall be provided parallel with the seat. The space shall be 36 inches (915 mm) wide minimum and shall extend forward 48 inches (1220 mm) minimum from a line located 12 inches (305 mm) behind the rear edge of the seat. The clear deck space shall have a slope not steeper than 1:48.



**Figure 1009.2.3 Clear Deck Space at Pool Lifts**

**1009.2.4 Seat Height.** The height of the lift seat shall be designed to allow a stop at 16 inches (405 mm) minimum to 19 inches (485 mm) maximum measured from the deck to the top of the seat surface when in the raised (load) position.

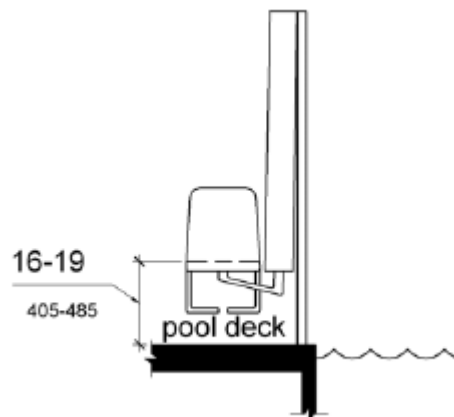

**Figure 1009.2.4 Pool Lift Seat Height**

**1009.2.5 Seat Width.** The seat shall be 16 inches (405 mm) wide minimum.

**1009.2.6 Footrests and Armrests.** Footrests shall be provided and shall move with the seat. If provided, the armrest positioned opposite the water shall be removable or shall fold clear of the seat when the seat is in the raised (load) position.

**EXCEPTION:** Footrests shall not be required on pool lifts provided in spas.

**1009.2.7 Operation.** The lift shall be capable of unassisted operation from both the deck and water levels. Controls and operating mechanisms shall be unobstructed when the lift is in use and shall comply with 309.4.

**Advisory 1009.2.7 Operation.** Pool lifts must be capable of unassisted operation from both the deck and

# ADAAG RECREATION FACILITIES

## SWIMMING POOLS, WADING POOLS AND SPAS

water levels. This will permit a person to call the pool lift when the pool lift is in the opposite position. It is extremely important for a person who is swimming alone to be able to call the pool lift when it is in the up position so he or she will not be stranded in the water for extended periods of time awaiting assistance. The requirement for a pool lift to be independently operable does not preclude assistance from being provided.

**1009.2.8 Submerged Depth.** The lift shall be designed so that the seat will submerge to a water depth of 18 inches (455 mm) minimum below the stationary water level.

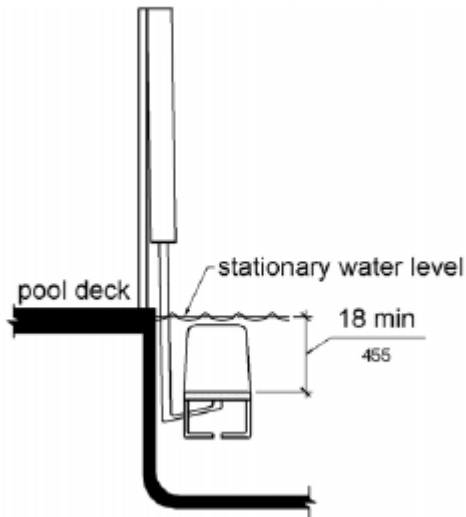

**Figure 1009.2.8 Pool Lift Submerged Depth**

**1009.2.9 Lifting Capacity.** Single person pool lifts shall have a weight capacity of 300 pounds. (136 kg) minimum and be capable of sustaining a static load of at least one and a half times the rated load.

**Advisory 1009.2.9 Lifting Capacity.** Single person pool lifts must be capable of supporting a minimum weight of 300 pounds (136 kg) and sustaining a static load of at least one and a half times the rated load. Pool lifts should be provided that meet the needs of the population they serve. Providing a pool lift with a weight capacity greater than 300 pounds (136 kg) may be advisable.

**1009.3 Sloped Entries.** Sloped entries shall comply with 1009.3.

**Advisory 1009.3 Sloped Entries.** Personal wheelchairs and mobility devices may not be appropriate for submerging in water. Some may have batteries, motors, and electrical systems that when submerged in water may cause damage to the personal mobility device or wheelchair or may contaminate the pool water. Providing an aquatic wheelchair made of non-corrosive materials and designed for access into the water will protect the water from contamination and avoid damage to personal wheelchairs or other mobility aids.

**1009.3.1 Sloped Entries.** Sloped entries shall comply with Chapter 4 except as modified in 1109.3.1 through 1109.3.3.

**EXCEPTION:** Where sloped entries are provided, the surfaces shall not be required to be slip resistant.

# ADAAG RECREATION FACILITIES

## SWIMMING POOLS, WADING POOLS AND SPAS

**1009.3.2 Submerged Depth.** Sloped entries shall extend to a depth of 24 inches (610 mm) minimum and 30 inches (760 mm) maximum below the stationary water level. Where landings are required by 405.7, at least one landing shall be located 24 inches (610 mm) minimum and 30 inches (760 mm) maximum below the stationary water level.

**EXCEPTION:**

In wading pools, the sloped entry and landings, if provided, shall extend to the deepest part of the wading pool.

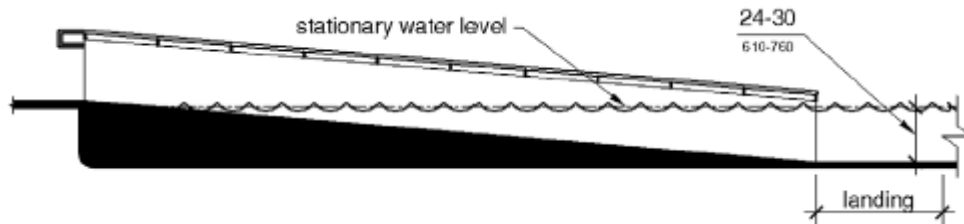
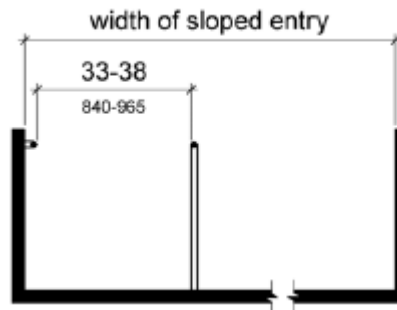

**Figure 1009.3.2 Sloped Entry Submerged Depth**

**1009.3.3 Handrails.** At least two handrails complying with 505 shall be provided on the sloped entry. The clear width between required handrails shall be 33 inches (840 mm) minimum and 38 inches (965 mm) maximum.

**EXCEPTIONS:**

1. Handrail extensions specified by 505.10.1 shall not be required at the bottom landing serving a sloped entry.
2. Where a sloped entry is provided for wave action pools, Leisure Rivers, sand bottom pools, and other pools where user access is limited to one area, the handrails shall not be required to comply with the clear width requirements of 1009.3.3.
3. Sloped entries in wading pools shall not be required to provide handrails complying with 1009.3.3. If provided, handrails on sloped entries in wading pools shall not be required to comply with 505.



**Figure 1009.3.3 Handrails for Sloped Entry**

**1009.4 Transfer Walls.** Transfer walls shall comply with 1009.4.

**1009.4.1 Clear Deck Space.** A clear deck space of 60 inches (1525 mm) minimum by 60 inches (1525 mm) minimum with a slope not steeper than 1:48 shall be provided at the base of the transfer wall. Where one grab bar is provided, the clear deck space shall be centered on the grab bar. Where two grab bars are provided, the clear deck space shall be centered on the clearance between the grab bars.

# ADAAG RECREATION FACILITIES

## SWIMMING POOLS, WADING POOLS AND SPAS

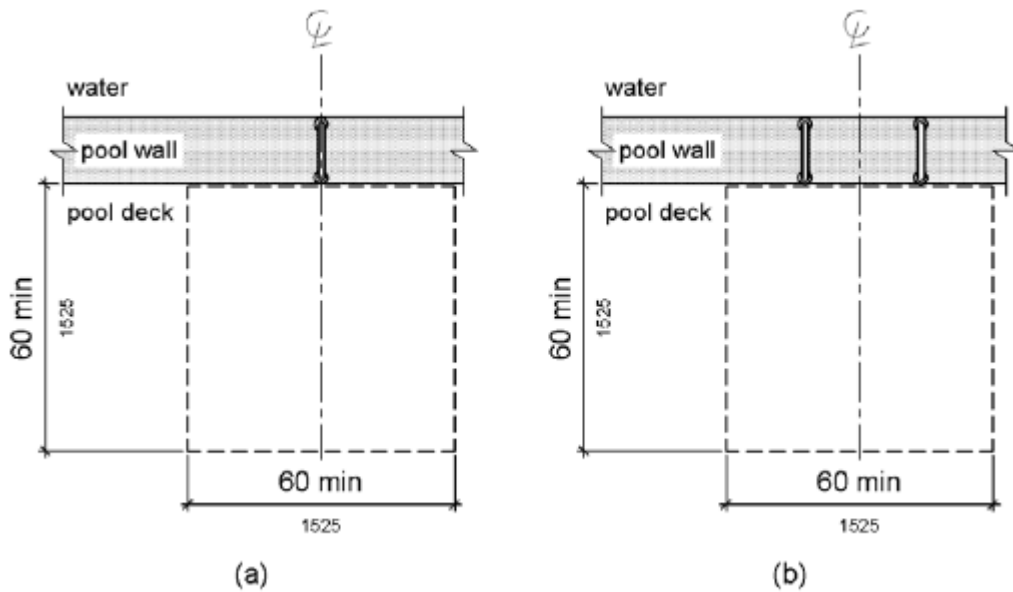

**Figure 1009.4.1 Clear Deck Space at Transfer Walls**

**1009.4.2 Height.** The height of the transfer wall shall be 16 inches (405 mm) minimum and 19 inches (485 mm) maximum measured from the deck.



**Figure 1009.4.2 Transfer Wall Height**

**1009.4.3 Wall Depth and Length.** The depth of the transfer wall shall be 12 inches (305 mm) minimum and 16 inches (405 mm) maximum. The length of the transfer wall shall be 60 inches (1525 mm) minimum and shall be centered on the clear deck space.

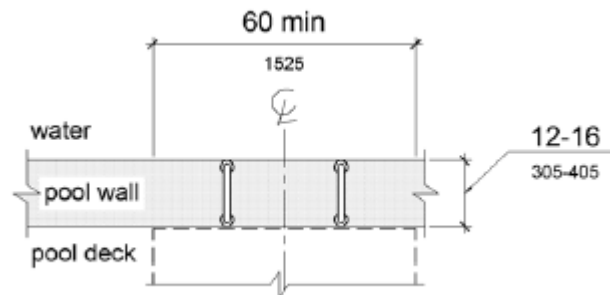

**Figure 1009.4.3 Depth and Length of Transfer Walls**

**1009.4.4 Surface.** Surfaces of transfer walls shall not be sharp and shall have rounded edges.

# ADAAG RECREATION FACILITIES

## SWIMMING POOLS, WADING POOLS AND SPAS

**1009.4.5 Grab Bars.** At least one grab bar complying with **609** shall be provided on the transfer wall. Grab bars shall be perpendicular to the pool wall and shall extend the full depth of the transfer wall. The top of the gripping surface shall be 4 inches (100 mm) minimum and 6 inches (150 mm) maximum above transfer walls. Where one grab bar is provided, clearance shall be 24 inches (610 mm) minimum on both sides of the grab bar. Where two grab bars are provided, clearance between grab bars shall be 24 inches (610 mm) minimum.

**EXCEPTION:** Grab bars on transfer walls shall not be required to comply with 609.4.

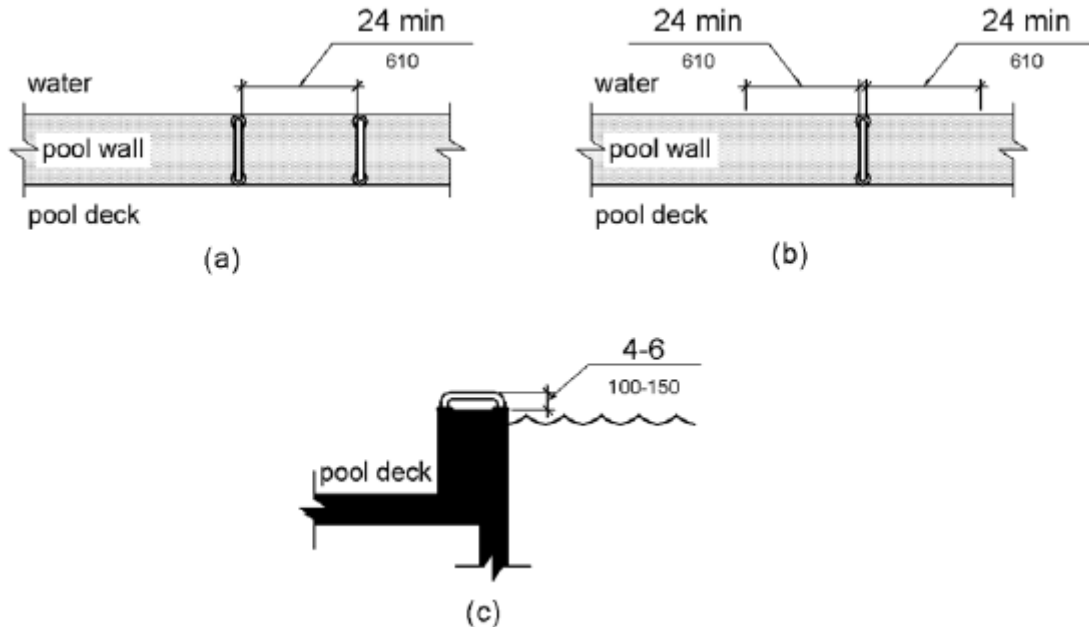

Figure 1009.4.5 Grab Bars for Transfer Walls

**1009.5 Transfer Systems.** Transfer systems shall comply with **1009.5**.

**1009.5.1 Transfer Platform.** A transfer platform shall be provided at the head of each transfer system. Transfer platforms shall provide 19 inches (485 mm) minimum clear depth and 24 inches (610 mm) minimum clear width.

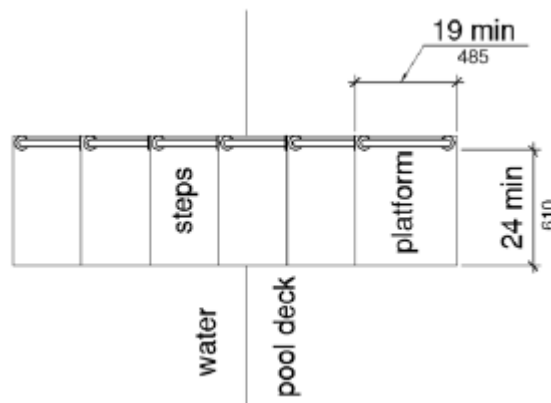

Figure 1009.5.1 Size of Transfer Platform



# ADAAG RECREATION FACILITIES

## SWIMMING POOLS, WADING POOLS AND SPAS

**1009.5.2 Transfer Space.** A transfer space of 60 inches (1525 mm) minimum by 60 inches (1525 mm) minimum with a slope not steeper than 1:48 shall be provided at the base of the transfer platform surface and shall be centered along a 24 inch (610 mm) minimum side of the transfer platform. The side of the transfer platform serving the transfer space shall be unobstructed.

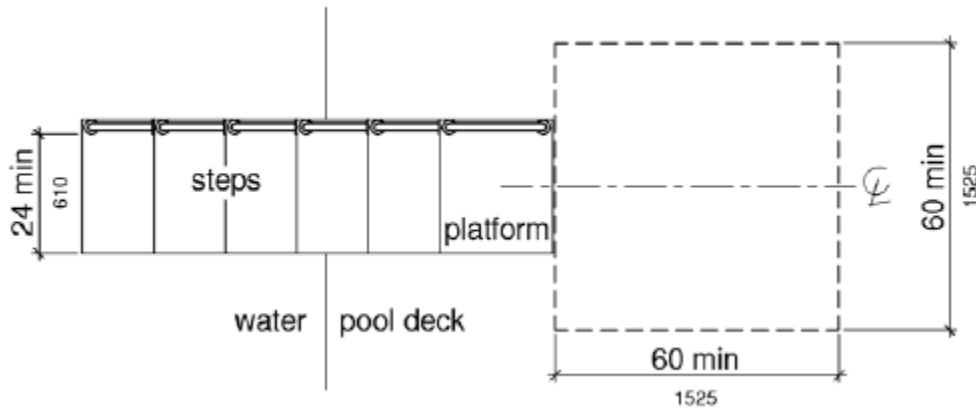
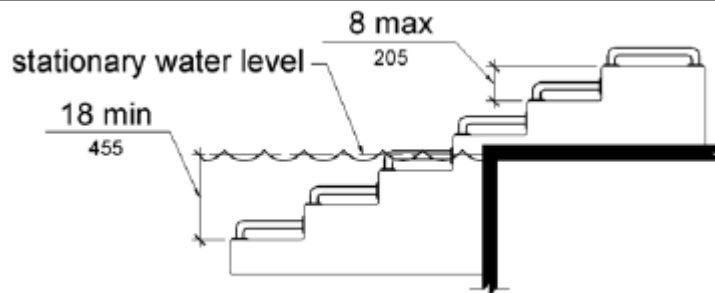

**Figure 1009.5.2 Clear Deck Space at Transfer Platform**

**1009.5.3 Height.** The height of the transfer platform shall comply with 1009.4.2.

**1009.5.4 Transfer Steps.** Transfer step height shall be 8 inches (205 mm) maximum. The surface of the bottom tread shall extend to a water depth of 18 inches (455 mm) minimum below the stationary water level.

**Advisory 1009.5.4 Transfer Steps.** Where possible, the height of the transfer step should be minimized to decrease the distance an individual is required to lift up or move down to reach the next step to gain access.



**Figure 1009.5.4 Transfer Steps**

**1009.5.5 Surface.** The surface of the transfer system shall not be sharp and shall have rounded edges.

**1009.5.6 Size.** Each transfer step shall have a tread clear depth of 14 inches (355 mm) minimum and 17 inches (430 mm) maximum and shall have a tread clear width of 24 inches (610 mm) minimum.

# ADAAG RECREATION FACILITIES

## SWIMMING POOLS, WADING POOLS AND SPAS

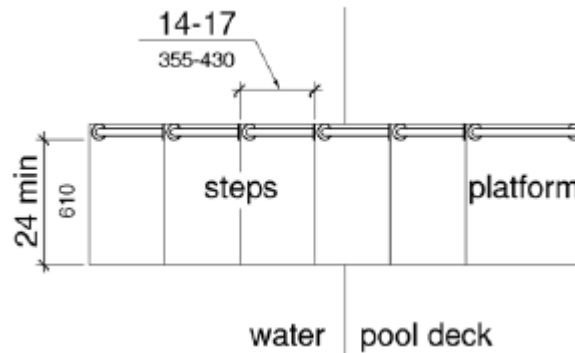

Figure 1009.5.6 Size of Transfer Steps

**1009.5.7 Grab Bars.** At least one grab bar on each transfer step and the transfer platform or a continuous grab bar serving each transfer step and the transfer platform shall be provided. Where a grab bar is provided on each step, the tops of gripping surfaces shall be 4 inches (100 mm) minimum and 6 inches (150 mm) maximum above each step and transfer platform. Where a continuous grab bar is provided, the top of the gripping surface shall be 4 inches (100 mm) minimum and 6 inches (150 mm) maximum above the step nosing and transfer platform. Grab bars shall comply with **609** and be located on at least one side of the transfer system. The grab bar located at the transfer platform shall not obstruct transfer.

**EXCEPTION:** Grab bars on transfer systems shall not be required to comply with 609.4.

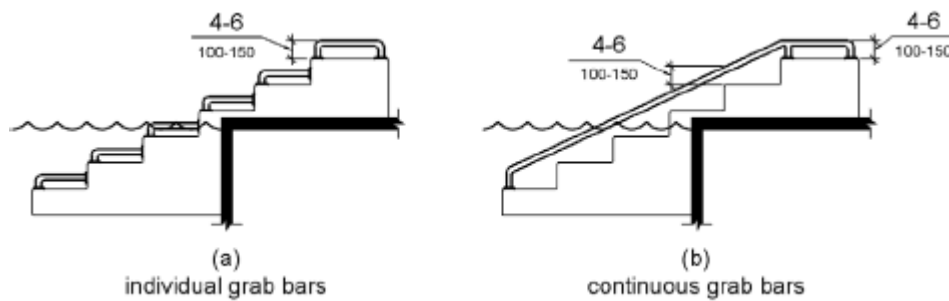

Figure 1009.5.7 Grab Bars

**1009.6 Pool Stairs.** Pool stairs shall comply with 1009.6.

**1009.6.1 Pool Stairs.** Pool stairs shall comply with **504**.

**EXCEPTION:** Pool step riser heights shall not be required to be 4 inches (100 mm) high minimum and 7 inches (180 mm) high maximum provided that riser heights are uniform.

**1009.6.2 Handrails.** The width between handrails shall be 20 inches (510 mm) minimum and 24 inches (610 mm) maximum. Handrail extensions required by 505.10.3 shall not be required on pool stairs.